

Dual fuel boiler

thermiⁿator II touch Logs + Pellets



- ✓ Powerful products
- ✓ Modern design
- ✓ Low emissions

Log wood



+



Pellets



Wood gasification technology

- ✓ Dual fuel boiler since 17 years!
- ✓ Our experience is your advantage!
- ✓ Good heat grows!

SOLARFOCUS

All boilers with touch screens

It's reassuring to know you can have flexible heating ...



Manual, but economical heating with **log wood**

... and you decide, how much you save!



Easy and straightforward
with **pellets**

Optionally available with fully automatic
switching from wood logs to pellets!

Sophisticated technology in detail

thermi^{nator} II touch dual fuel boiler – Pellet storage tank with suction auger



Legend:

- 1 Level sensor
- 2 Pellet storage tank 110 litres
- 3 Backburn slide
- 4 Down pipe
- 5 Auger feeder
- 6 Gear motor
- 7 Pellet flange for automatic loading
- 8 Suction turbine

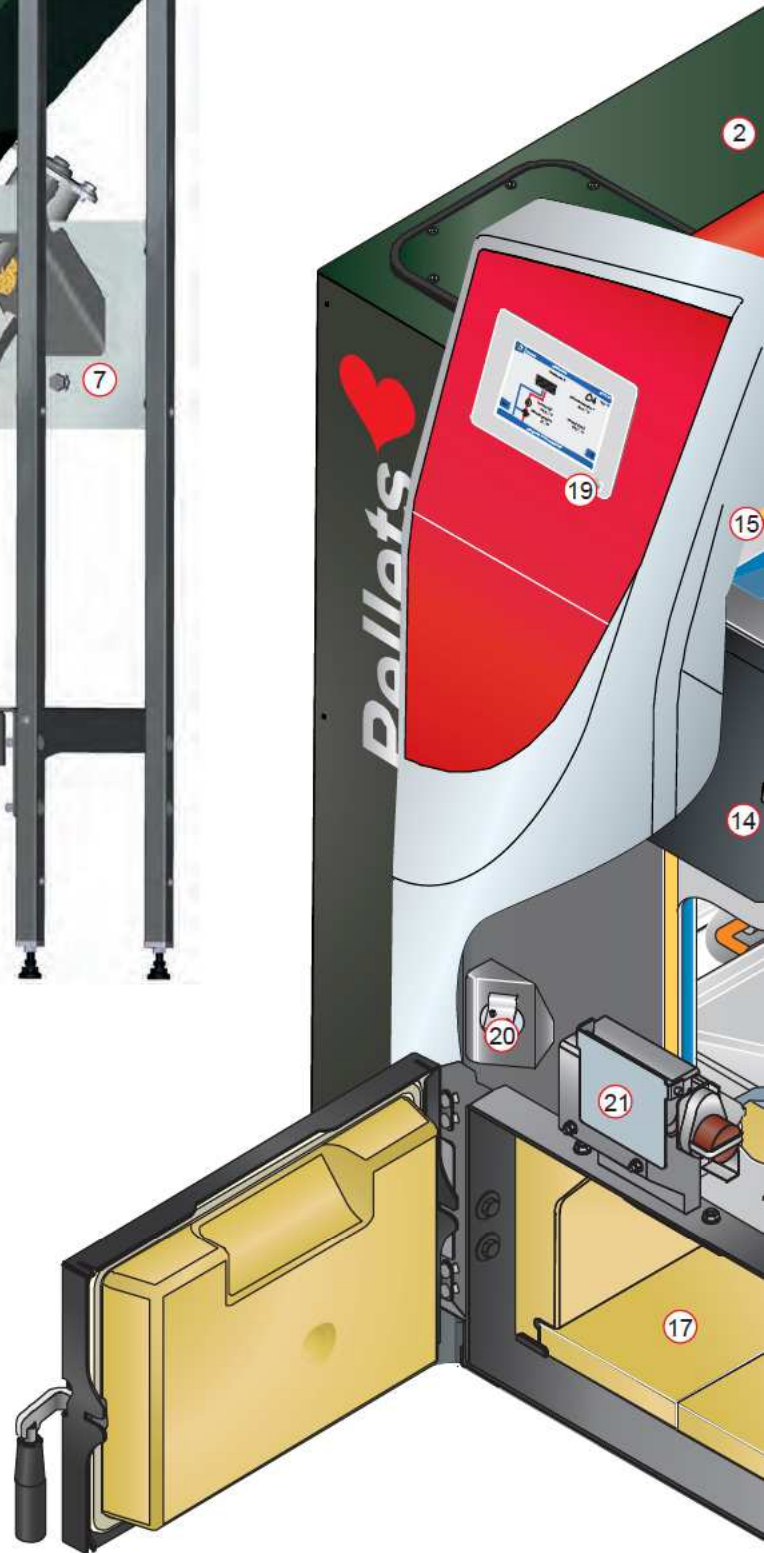

Optionally available with **fully automatic**

YOUR PRICE ADVANTAGE:

All boilers have their electrics installed ex works – the functionality of all components is checked – ready-to-plug delivery with assembled enclosure!

Efficiency with pellets: up to **95,4 %**

Efficiency with log wood: up to **94,4 %**

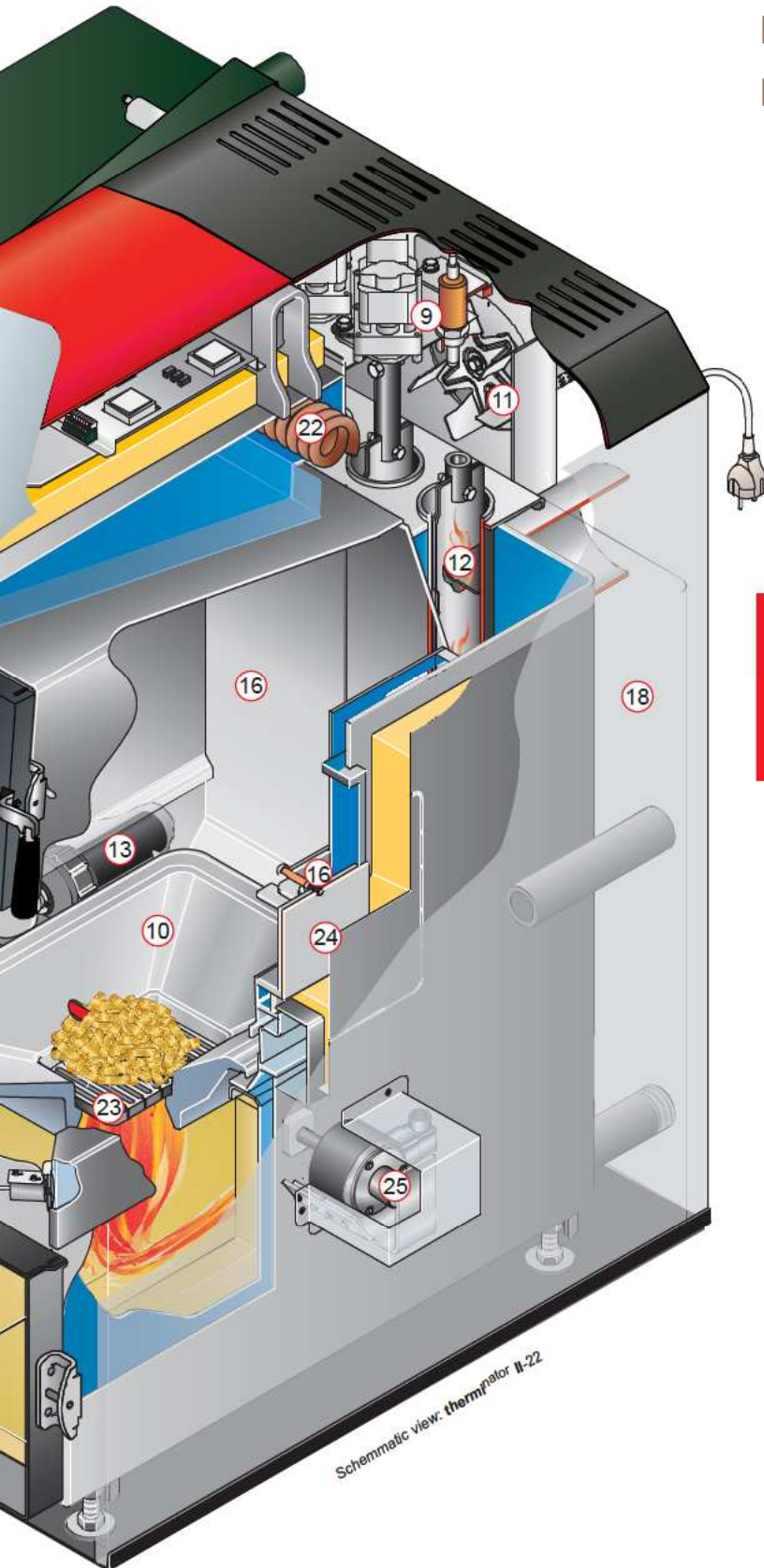

NOTE:

If required, the **thermi'nator II touch** with blanking flange can be retrofitted for automatic pellet operation!

Legend:

- 9 Lambda sensor
- 10 Air-cooled crucible made of cast chrome steel
- 11 Induced Draft fan
- 12 Automatic heat exchanger cleaning system
- 13 Automatic ignition by hot air fan
- 14 Filling door
- 15 Safety temperature limiter (STL)
- 16 Stainless steel filling chamber
- 17 Generous ash chamber lined with fireclay
- 18 Casing
- 19 Control system *eco*manager-touch
- 20 Primary air control
- 21 Secondary air control with servomotor
- 22 Backup battery
- 23 Grate
- 24 Flange for automatic filling (left or right)

switching from wood logs to pellets!

Your benefits

Generous stainless steel filling chamber

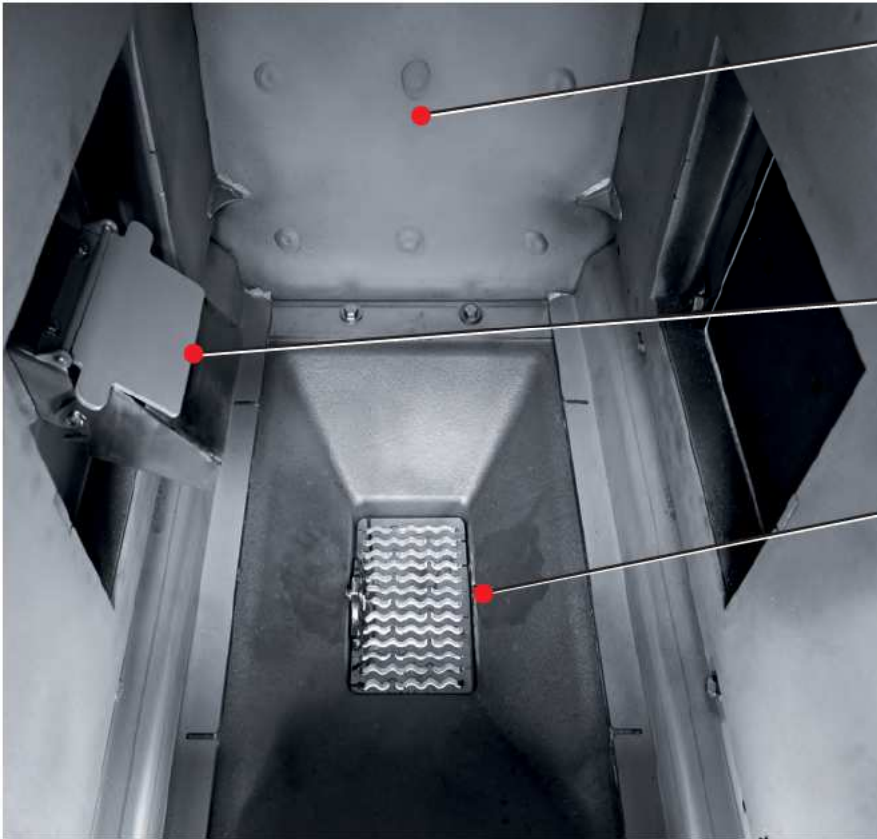

Generous stainless steel filling chamber

Allows heating pellets and log wood in a single combustion chamber. 10-year warranty maintenance contract according to the filling chamber.

Pellet insertion

The bed of embers is not disturbed, as pellets drop onto the bed of embers from above. Optional left or right.

Automatic ignition

A hot-air blower ignites the pellets or the wood chips fully automatically at the preset time.

Gasifier technology

Complete burning by top flame temperatures about 1.200°C.



Lambda sensor

Experience with lambda technology since 1981. Guarantees energysaving combustion through adjustment to the fuel.



Heat exchanger cleaning

Turbulators with flow-optimised guide plates clean the heat exchangers automatically and ensure low flue gas temperatures.

Rotating scraping edge

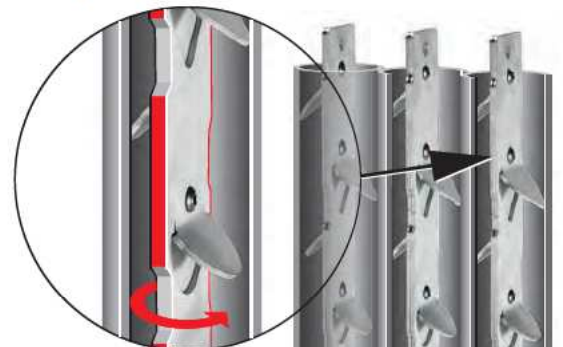

Flow-optimised guide plates

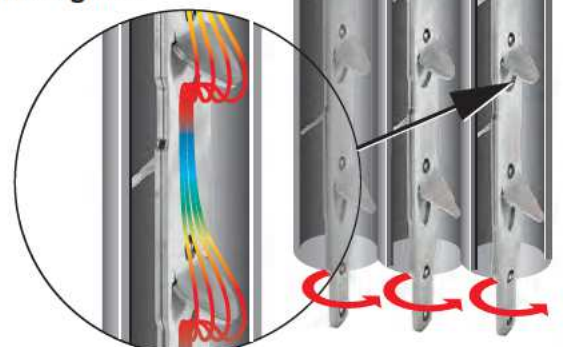



Generously dimensioned ash chamber

In the **thermiⁿator II** we have placed emphasis on designing a particularly generous ash chamber, in order to achieve longer emptying intervals.



Induced draft fan

The combustion air needed in the various areas is sucked in by the speedcontrolled induced draft fan. It is controlled by the microprocessor which is built into the control system by the measuring values determined by the lambda sensor.



Automatic ignition

The boiler is ignited automatically via a hot-air blower at a preset time or when energy is required. Requirement: Request from heating circuit control system.



Flange for automatic loading

Pellet flange optional left or right. Also available with blanking flange - so that you can later switch to pellet operation if you wish.



Pellet auger

The auger automatically conveys the pellets to the boiler grate. It is equipped with motor and tested back-burn safety cut-out.



Automatic switching from wood logs to pellets (Option)

Flange-mounted on the boiler side opposite the ignition fan. A special motor transfers vibrations to the stainless steel grate in adjustable time intervals. Boilers manufactured after 2012 can be retrofitted at any time.

30 years of experience with biomass heating

✓ The technology and combustion principle of the thermi^{nator} II

Metered combustion to fire a variety of solid fuels with unsurpassed combustion quality. The unique technology of the thermi^{nator} II touch offers the option of loading the same loading chamber manually, or automatically. The thermi^{nator} II touch reaches only a fraction of permitted emissions, even when operating on partial loads.

✓ Air flow

The lambda-controlled secondary air mixture makes it possible to achieve unsurpassed combustion quality with the highest efficiency ratios, even when burning different biomass fuels (pellets, log wood, waste wood,...)

✓ The downfiring combustion technology

The unique feature of the downfiring technology is that the burning flame points downwards. The fire bed is not disturbed. The methane gas (1) from the fuel is released into the patented, hopper shaped chromium steel crucible (wood gasification) and the burning methane gas is sucked through the boiler by the speedregulated ID fan. Temperatures of up to 1,200 °C (3) are created in the combustion chamber. This ensures that the fuel is completely combusted. The final residues of combustible items, in the ash (4) are also burnt.

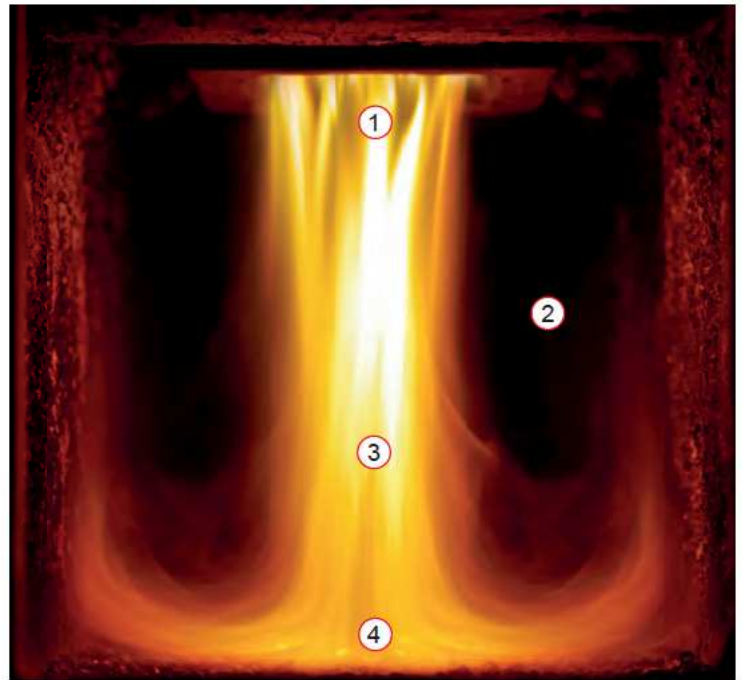

Wood gasification technology

Your benefit

- Firing control optimises the burner automatically.
- The downfiring technology guarantees optimum fuel usage
NO moving parts in the combustion chamber,
NO charred fuel-residues remain in the ashes.
- Compact, space-saving construction
- Independently tested for both operating modes
(log wood + pellets)
- 30 years of experience in lambda sensor technology
- Dual fuel boilers since 17 years!

Wood gasification technology with the highest levels of efficiency

30 years of experience in the development of wood gasification boilers have resulted in a perfectly engineered product.

Only ONE combustion chamber

- The unique design of the **thermi^{nator} II** touch allows you to burn pellets and log wood in one combustion chamber.
- The generously dimensioned stainless steel filling chamber is designed to accommodate logs with a length of half a metre (max. 56 cm). Large filling chamber – long burning time. Pellet operation is fully automatic.

Perfect combustion technology

- Perfect combustion thanks to the downfiring combustion technology in conjunction with the lambda sensor and the induced draft fan.
- Highest level of efficiency with minimum emission values relieve the pressure on your wallet and on our environment.

Ember retention

- The boiler ignites the log wood fully automatically via a hot-air fan at the times you set.
- You can select the "Ember retention" function: Embers then remain in the combustion chamber on the hopper grate for a certain time. This facilitates firing up after a complete burn-out.

Ash box

- Large ash box, compressed fireclay bricks.
- Extends the intervals of time between emptying the ashes. Easy servicing and a long life cycle of the high-temperature combustion chamber thanks to individually assembled fireclay bricks.

Heat exchanger cleaning

- Reamers clean the walls of the heat exchanger in pre-set intervals. Raising the flue gas temperature results in a loss of efficiency. A clean heat exchanger saves fuel!
- AUTOMATIC means AUTOMATIC! A constant level of efficiency saves energy costs. No manual after-cleaning needed. Maintenance-free.

Ignition

- The boiler is equipped with a fully automatic ignition.
- This means: The ignition is not only fully automatic at the time predefined by you in automatic operation with pellets, but also if you fill the boiler with logs.

Control

- Intuitive touch screen control **eco^{manager-touch}**.
- The latest control concept with user-friendly operation controls your boiler in terms of performance and firing.

Intelligent control

Everything controlled with **eco**manager-touch





The core of your heating system the intelligent control *eco*manager-touch

To meet your daily comfort requirements, the controller is particularly important. The user determines when the heating comes on and how warm it should be.

- 7" VGA colour touch display: Guarantees simple, logical operation. Powerful microprocessor with power-saving standby mode.
- 1 weather-controlled heating circuit
3-point heating circuit curve, up to 8 modules are possible (option).
- 1 DHW tank charging circuit, up to 4 modules are possible (option).
- Fresh water module controllable with or without recirculation pump (option).
- 2 x three-circuit or 4 x two-circuit solar controllers possible (option). Also suitable for high-efficiency pumps.
- **mySOLARFOCUS** app: App for smartphone (Android and Apple) with attractive design for intuitive operation of the main heating parameters, such as room and flow temperature incl. heating times. Possibility to visualise the solar yield with installed heat quantity meter and control via *eco*manager-touch
- Weatherman function: Takes the weather forecast for the system's location into consideration. In conjunction with a solar-thermal system, prevents uneconomical start of the boiler when the weather forecast is good.

*eco*manager-touch

helps you to measure and control!

Changing outdoor temperatures have to be taken into consideration as precisely as very personal living habits. If the boiler is used in combination with a solar energy system, the burner only starts when the required heating energy cannot be fully provided by the solar energy system. This prevents any uneconomical boiler starts.

The *eco*manager-touch is very easy to use. It enables individual settings and ensures a perfectly tailored heating system.



Weather-depending control + mySOLARFOCUS app

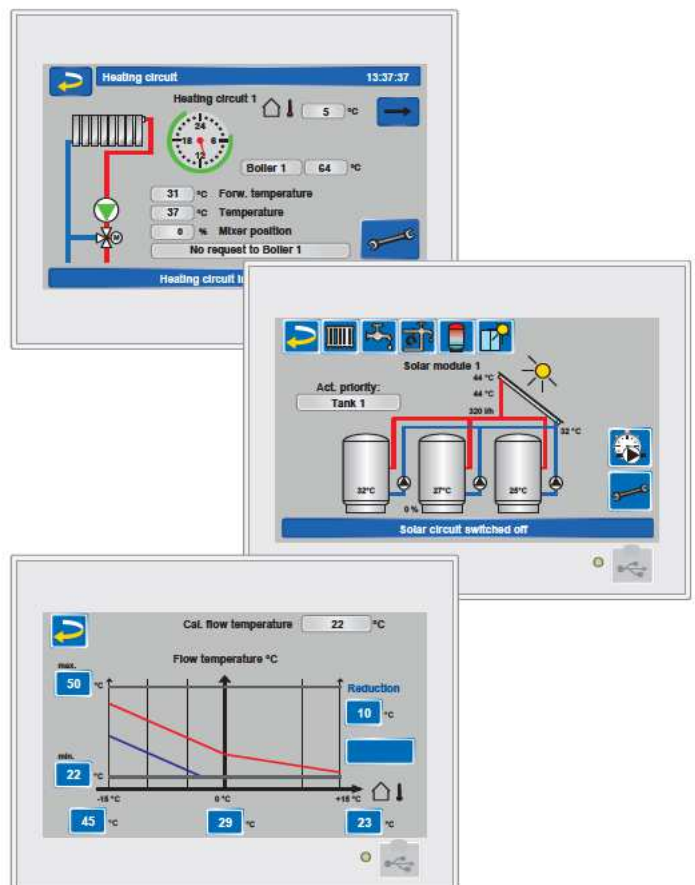

Sustainable – renewable – cost-efficient

Now switch to pellets!

Comfortable delivery with tank truck



- Pellets are blown into the storage room with a tank truck similar to oil.
- Heating value: 1 kg pellets approx. 4,9 kWh
2 kg pellets = 1 l fuel oil
- Storage volume: 1 m³ approx. 650 kg

Make sure you get good-quality pellets



**ENplus –
Der neue Maßstab
für Holzpellets**

- Using pellets of good quality has several advantages: High-quality pellets achieve higher efficiency rates. They also mean that the boiler needs cleaning less frequently and has a longer service life.
- SOLARFOCUS recommends that you use only tested pellets. EN 14961-2-ENplus-A1 – the new benchmark for wood pellets. This means optimum heating values and protects your heating system.

thermi^{nator} II - Manual filling of storage box



- The storage box has a capacity of 250 litres.
May be mounted on the right or left
- Vacuum extractor can be retrofitted if necessary.

Storage and feeding systems

thermi^{nator} II – Suction heads and diverter for suction heads manual or automatic

- Maximum hose length
Diverter – boiler max. 20 m
Maximum auger height
Diverter – boiler max. 2.5 m
- Optimal utilisation of space
Minimal installation effort
Also suitable for angular storage areas/rooms.



thermi^{nator} II – Pellet box for vacuum system with auger

Extraction with auger

- Maximum hose length = 35 m
Maximum height distance = 5 m

Extraction with suction head

- Maximum hose length = 20 m
Maximum height distance = 2.5 m



Pellet box 350 litre with suction head manual filling



thermi^{nator} II – Transport via auger for room output

- Max. auger length = 6 m
May be mounted on the right or left
- The storage area can be completely emptied through the installation of a sloping floor.



thermi^{nator} II – Direct extraction from the pellet box

- Max. auger length 6 m
Optionally on the left or right
- For damp storage areas/rooms
No construction effort required.



Perfectly combined with solar plant

thermiⁿator II with stratified buffer storage tank and fresh water module

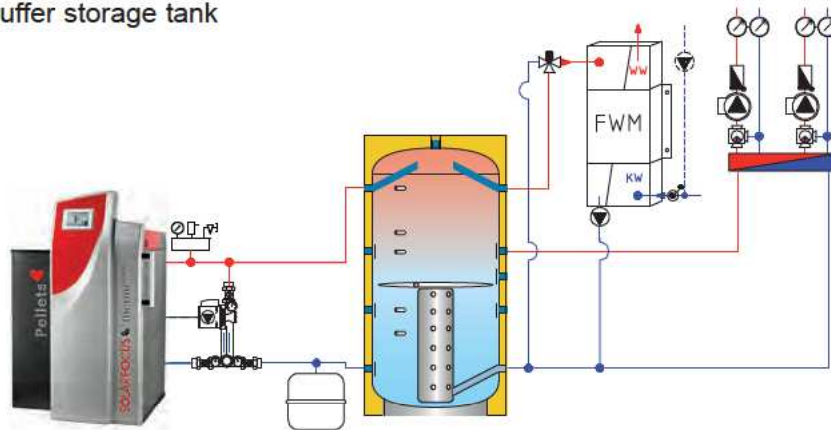

thermiⁿator II with HYKO storage tank and solar plant

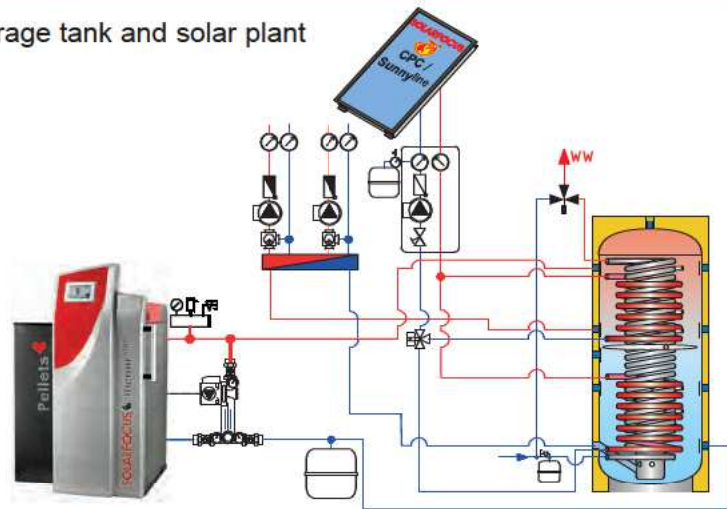

thermiⁿator II with stratified buffer storage tank, stratified load module, fresh water module and solar plant

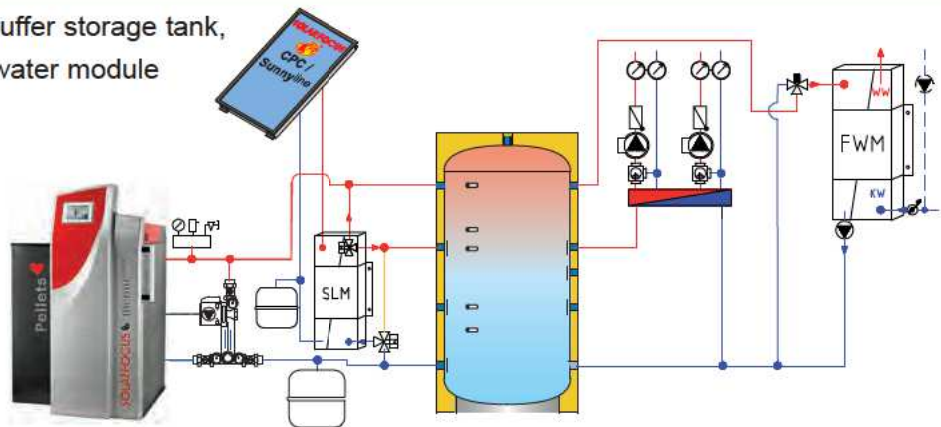

thermiⁿator II with stratified buffer storage tank, drinking water storage tank and solar plant

More hydraulic schemes are available - we can help you by planning!

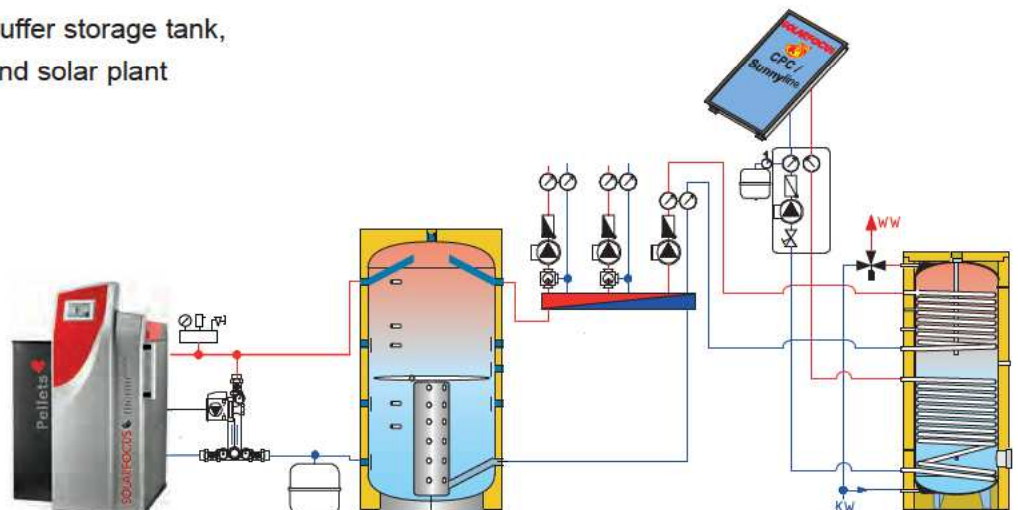



INNOVATION - ECONOMY – QUALITY

SOLARFOCUS shapes the future with products that serve mankind and protect the environment.

SOLARFOCUS is committed to researching, developing, manufacturing and selling environmental technology in the fields of:

Biomass heating,
Solar systems,
Storage technology and
Fresh water technology

SOLARFOCUS are one step ahead: The research, development and cooperation with research institutes and prestigious partners has led to our dynamic development. Our products are on offer throughout Europe. The courses and seminars held on a permanent basis with our partners guarantee personalised advice and professional installers for you.

AWARDS:

- Young entrepreneur's Award
- Innovations Award 1995
- Pegasus in Gold
- Environmental Protection Award of the Upper Austrian Region
- Innovation Award "EnergieGenie" 2003
- House Technology Award 2004
- Innovation Award "EnergieGenie" 2011
- Italian innovation prize for energy-efficient technologies 2012
- Polish Innovation Award „Zloty Medal" 2012 and 2013
- Slovenian Innovation Award „Energetika" 2014
- Best Business Award 2014
- UK Built It Award 2015
- Innovation Award "EnergieGenie" 2016

and many more confirm our philosophy.



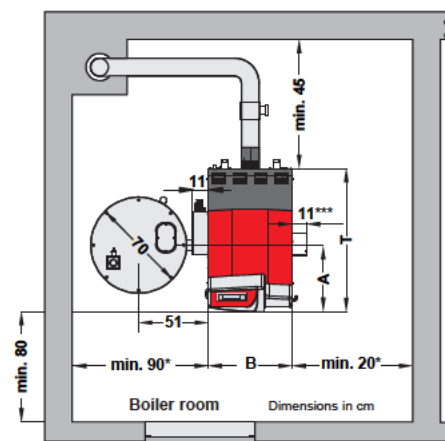
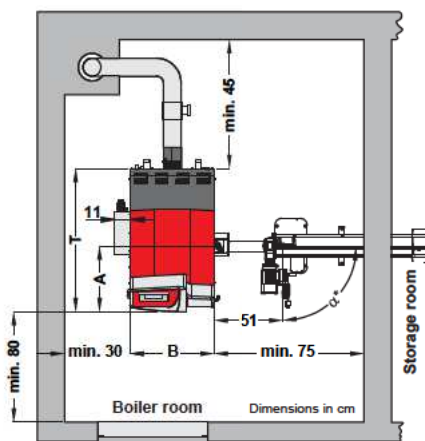
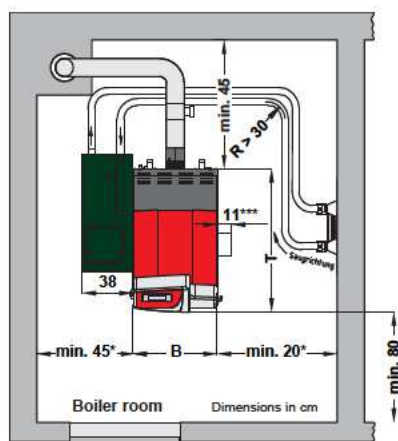

thermi ⁿ ator II		22	30	40	49	60
Power	[kW]	22	30	40	49	60
Depth without fan (T)	[cm]	104	104	115	136	136
Total depth	[cm]	120	120	130	151	151
Width without ignition (B)	[cm]	62	62	67	83	83
Height incl. adjustable feet****	[cm]	155	155	166	167	167
Minimum room height	[cm]	168	168	186	186	186
DM flue pipe	[cm]	13	13	15	20	20
Height flue pipe centre****	[cm]	78	78	88	90	90
Position pellet feeder (A)	[cm]	45	45	47	54	54
Weight	[kg]	534	534	652	777	777
Water content	[l]	90	90	126	188	188
Filling chamber volume	[l]	145	145	186	290	290
Maximum wood length	[cm]	56	56	56	66	66
Filling chamber door W x H	[cm]	34 x 24	34 x 24	39 x 24	54 x 24	54 x 24

* Access to the back of the boiler must be provided! (approx. 45 cm on the left or right)

*** Automatically switching from log wood to pellets (optional).

** Covered length

**** Adjustable feet at maximum depth of thread

Everything from one supplier

Solar systems – Biomass heating – Storage technology – Fresh water technology

Tested state-of-the-art technology – EN ISO 9001 certified



Eliphot – Der neue Maßstab für Holzpellets



Your specialised dealer

SOLARFOCUS GmbH, Werkstrasse 1, A-4451 St. Ulrich/Steyr

e-mail: office@solarfocus.com Tel.: +43 (0) 7252 / 50 002 - 0

web: www.solarfocus.com Fax: +43 (0) 7252 / 50 002 - 10